

ES Se recomienda probar la luminaria de manera independiente antes de montar la instalación completa.

EN It is recommended to test the luminaire independently before mounting the complete installation.

FR Il est recommandé de tester le luminaire individuellement avant de monter l'installation complète.

Datos técnicos

Technical data / Données Techniques

Tensión de alimentación Voltage & Frequency Tension d'alimentation	220-240 V, 50-60 Hz, 0,1-0,5 A
Tipo de lámpara Lamp type / Lampe	T5/T8
Aislamiento eléctrico Electrical insulation Isolation électrique	Clase I / Class I Classe I
Temperatura de trabajo Work temperature / Température de fonctionnement	-20°C ≤ T ≤ +45°C

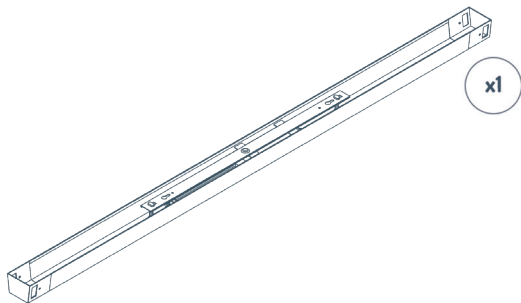

1

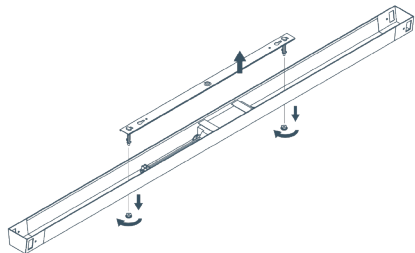

2

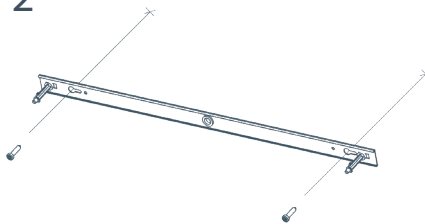

3

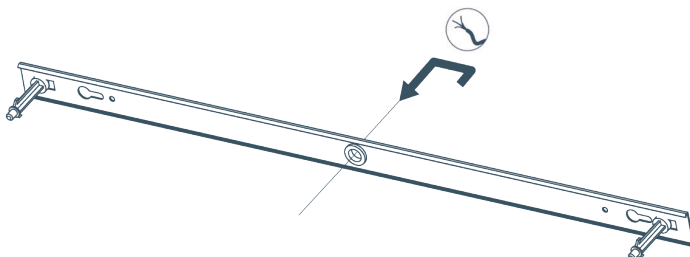

4

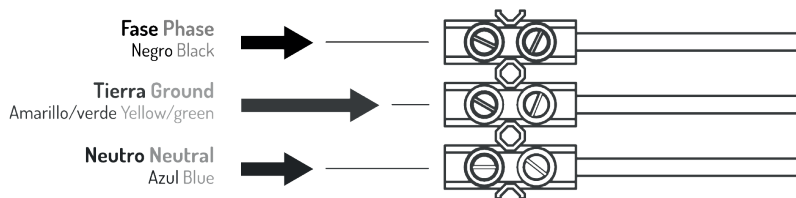

5

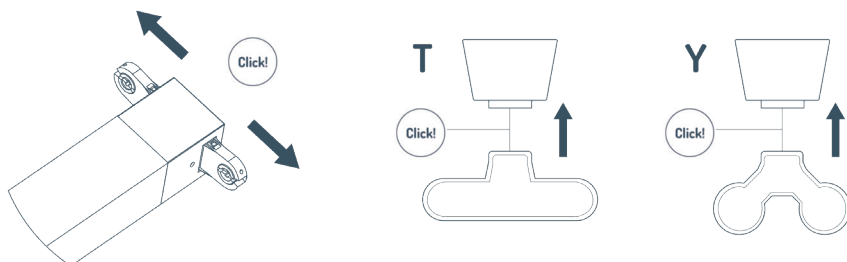

6

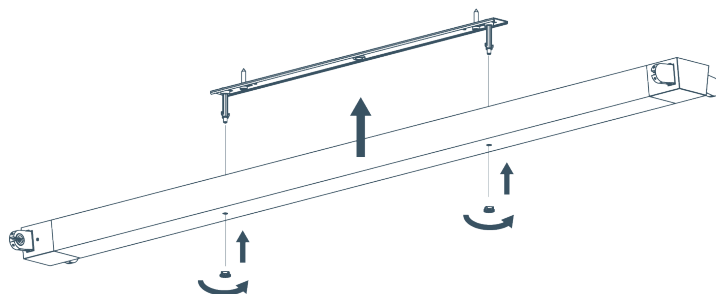

7

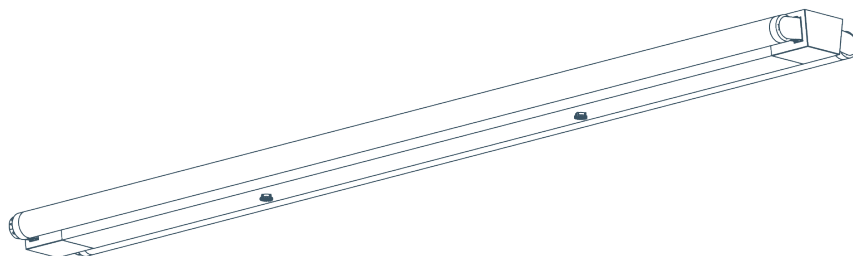

Calle Río Ésera, N°4, 50830, Villanueva de Gállego, Zaragoza, España
T. +34 976 185 809 | F. +34 976 186 086 | clientes@airfal.com | www.airfal.com

ES AIRFAL INTERNATIONAL S.L. no se hace responsable del incorrecto funcionamiento de las luminarias en cuya instalación no se hayan respetado todas las instrucciones expuestas. Cualquier modificación del producto anula la garantía.

EN AIRFAL INTERNATIONAL S.L. is not responsible for the incorrect operation of the luminaires in which installation all included instructions have not been followed. Any modification of the product voids the warranty.

FR AIRFAL INTERNATIONAL S.L. ne se fait pas responsable du mauvais fonctionnement des luminaires dont l'installation n'a pas été respecté toutes les instructions exposés. Toute modification du produit annule la garantie.